

**6/S1**  
v 3.3 (en)

## SOUND ATTENUATORS

PZ, PZC, PZM, PK

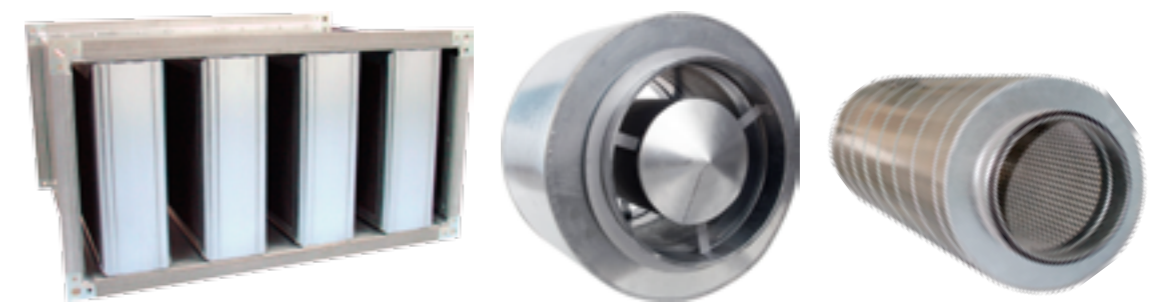



**RECTANGULAR ATTENUATOR**

- For sound attenuation in ventilation ducts and ventilated areas
- Aerodynamically shaped sound attenuation splitter reduces drag by 30% (energy savings)
- Sound attenuation splitters are made of flame retardant material, absorption material
- Splitters are constructed in three standard thicknesses:  $d = 100\text{ mm}$ ,  $d = 200\text{ mm}$  and  $d = 300\text{ mm}$
- Rectangular sound attenuators are available in five standard cross-section dimensions:  $d/s = 100/50$ ;  $100/100$ ;  $200/100$ ;  $200/200$  and  $300/100$
- Attenuator casing is made of galvanised steel, fitted with flanges meeting criteria given in the table on page 3
- Attenuators heavier than 300 kg are supplied in two or more sections, each single section lighter than 300 kg
- No maintenance required

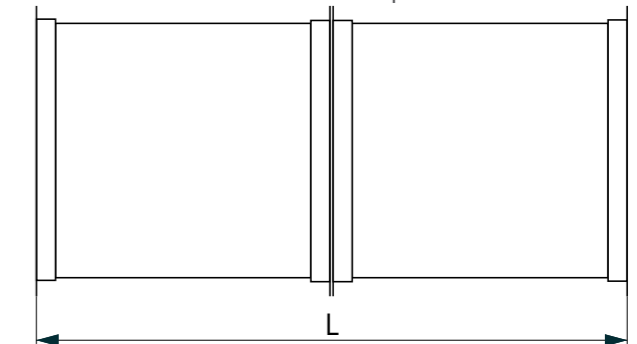
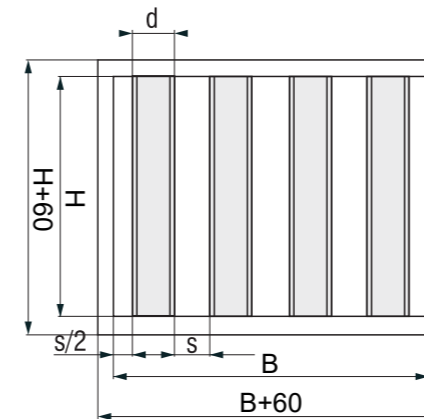

**SOUND ATTENUATION SPLITTER**

- Absorption material rock-wool, non-flammable, according to Class A2, to DIN 4102, Part 1.
- Significant attenuation in frequency span from 63 to 8000Hz.
- Aerodynamic splitter shape.
- Splitter cover (lining):

**Glass silk** - At air velocities higher than 20m/s  
**Reflective plates and glass silk (R)** - Half of each side of the splitter (alternatively centre up and centre down) is fitted with galvanised tin plates with other surface covered in glass silk  
**Perforated plate and glass silk (P)** - Half of each side of the splitter (alternatively centre up and centre down) is fitted with galvanised perforated tin plates with other surface covered in glass silk

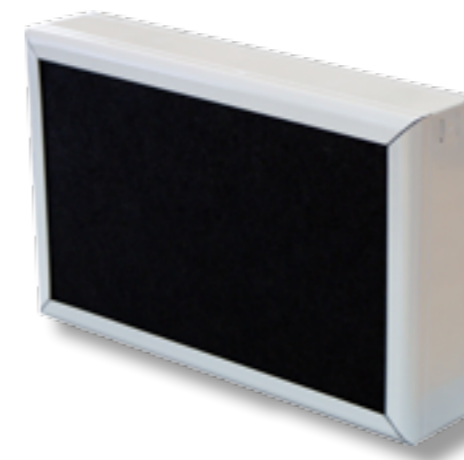

Meets standards VDI 6022, Part 1 and Part 3, DIN 1946, Part 2 and Part 4 and VDI 3803.

Definition of symbols:

B [m]	- Attenuator width	$f_m$ [Hz]	- Frequency
H [m]	- Attenuator height	$L_w$ [dB]	- Sound power level
L [m]	- Attenuator length	$L_{wA}$ [dB]	- Sound power level (A-weighting)
d [m]	- Splitter width	$De$ [dB]	- Sound attenuation
s [m]	- Splitter gap	$L_{pA}$ [dB(A)]	- Sound pressure level (A-weighting)
V [m <sup>3</sup> /h]	- Air flow rate		
v [m/s]	- Air velocity		
$\Delta p$ [Pa]	- Pressure drop		



Connecting more attenuators

- Sections of the attenuator are connected with built-in flanges and bolts
- Contact flange surfaces can be additionally fixed by reinforcement holders
- Prior to attenuator delivery, sections of each attenuator are assembled and disassembled in the factory.

Connection along width

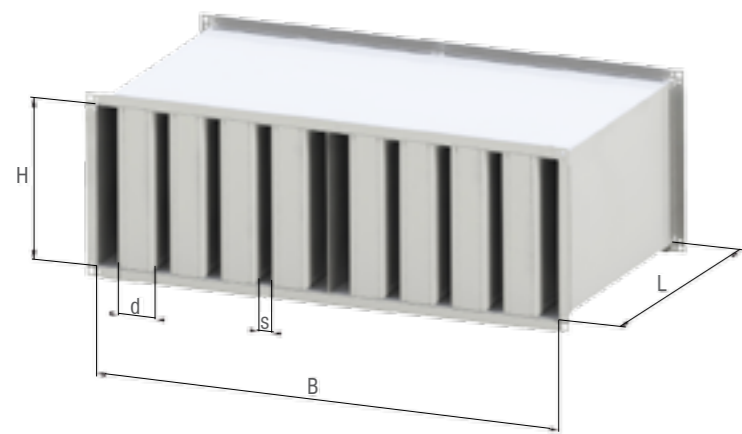

Connection along length



Connection along height



Four and eight sectional attenuator

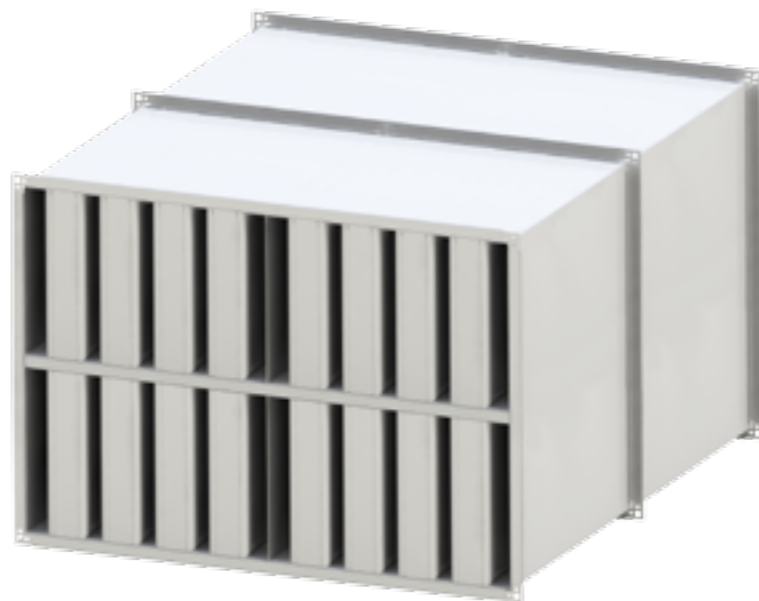

Attenuation diagram, type PZ 100/50

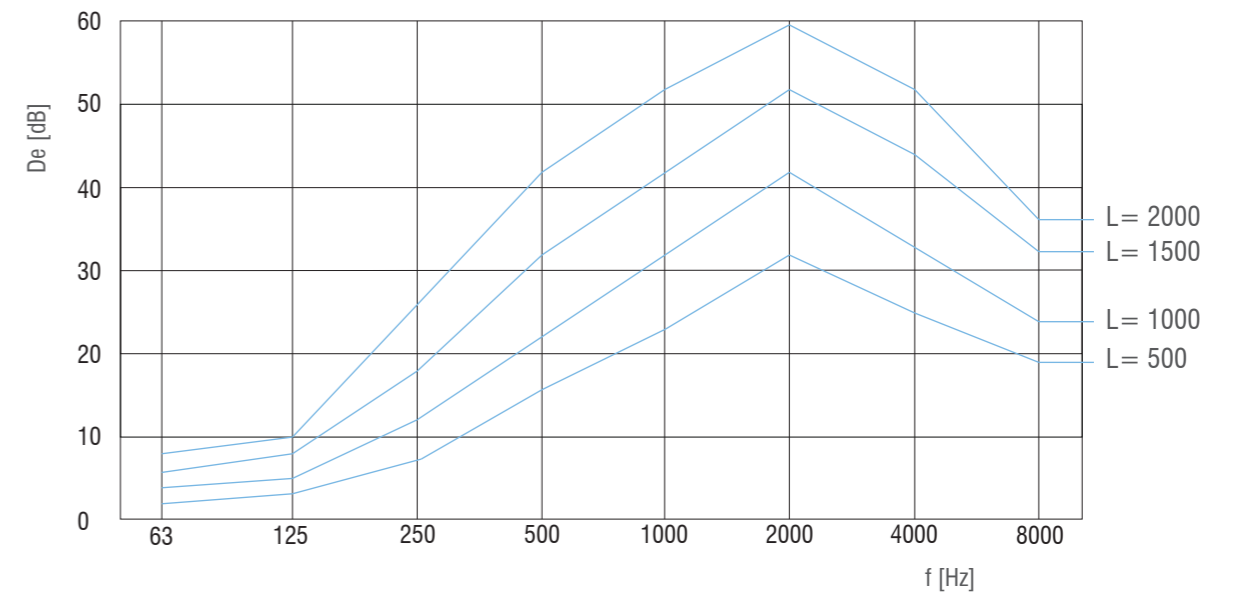

Selection diagram

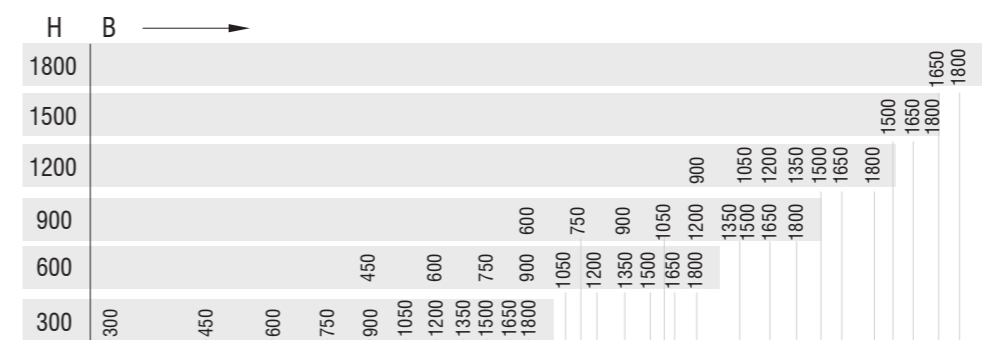

d/s = 100/50

Width B [mm]	No. of splitters
300	2
450	3
600	4
750	5
900	6
1050	7
1200	8
1350	9
1500	10
1650	11
1800	12

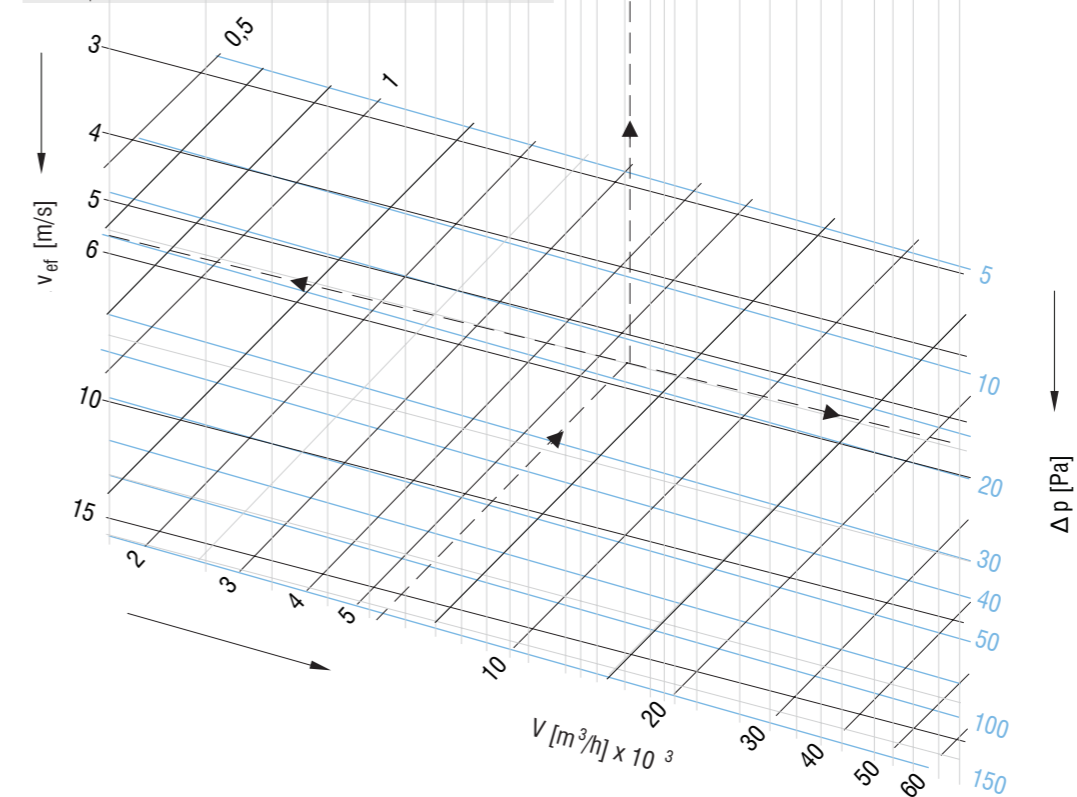

Attenuation diagram, type PZ 100/100

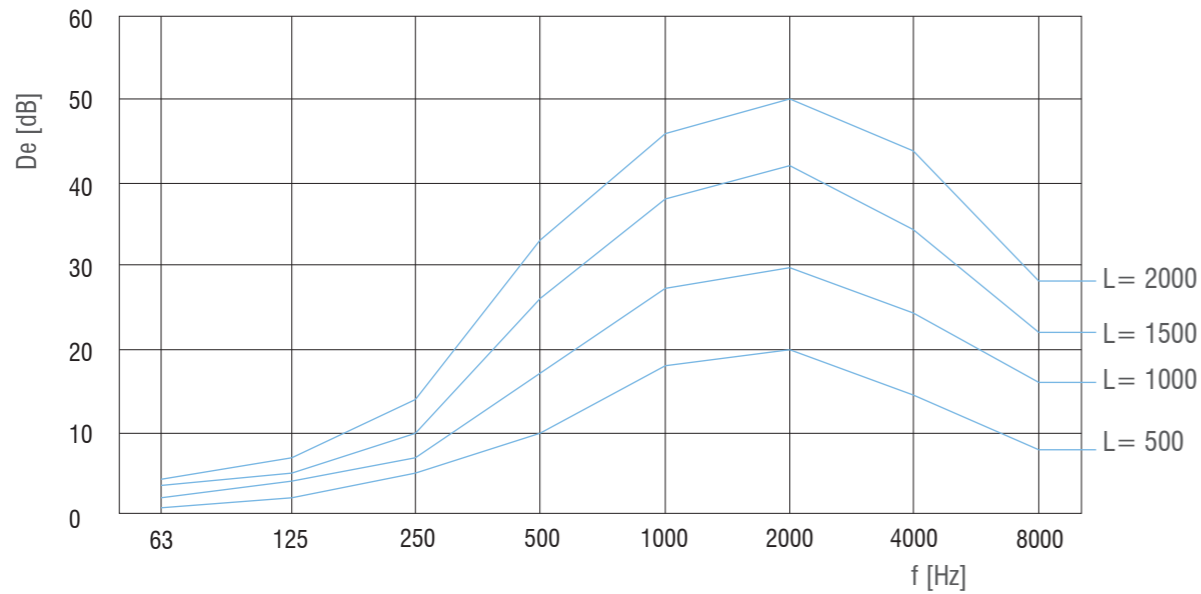

Selection diagram

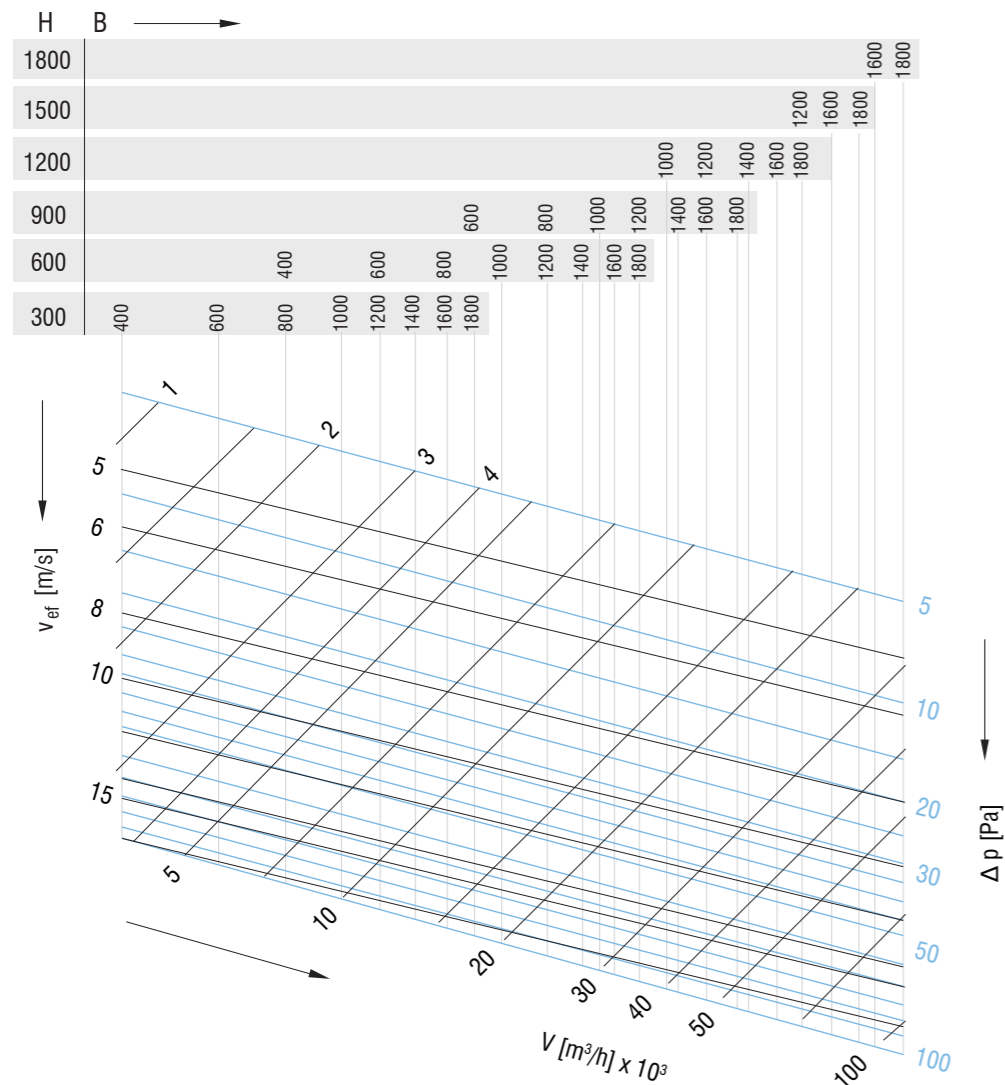

$d/s = 100/100$

Width B [mm]	No. of splitters
400	2
600	3
800	4
1000	5
1200	6
1400	7
1600	8
1800	9

Attenuation diagram, type PZ-R 100/50

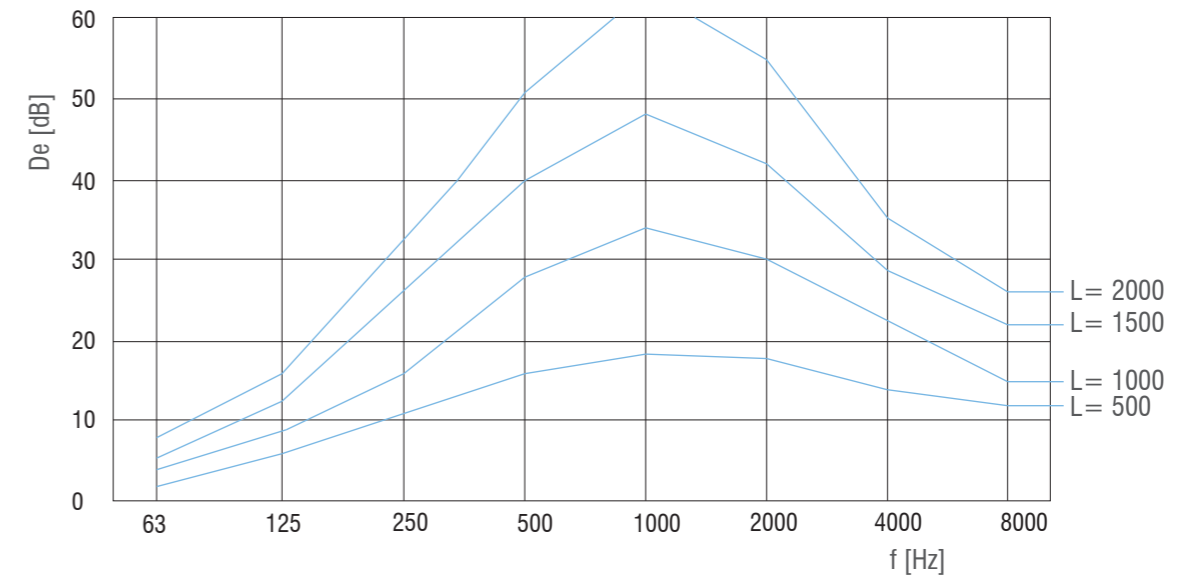

Example:

Given:  
Airflow rate:  $V = 5500 \text{ m}^3/\text{h}$   
Required attenuation: 24 dB (A) at 250 Hz

Solution:

Dg 1: PZ-R 100/50  
Attenuator length:  $L = 1500 \text{ mm}$

Dg 2: Effective air velocity  $v_{ef} = 5,5 \text{ m/s}$   
Pressure drop  $\Delta P_{tot} = 17 \text{ Pa}$   
Attenuator cross-section  $B \times H = 1350 \times 600$  or  $900 \times 900$

Dg. 7: Frequency Hz                      125    250    500

Flow regenerated noise dB (A)        39    31    27

$A_{tot} = B \times H = 0,81 \text{ m}^2$

Tab. 9: correction dB (A)                -2    -2    -2

Total air flow regenerated noise dB(A) 37    29    25

In each octave band noise values determined above have to be by 9 dB(A) lower than the attenuated source noise measured after the attenuator (see Figure).

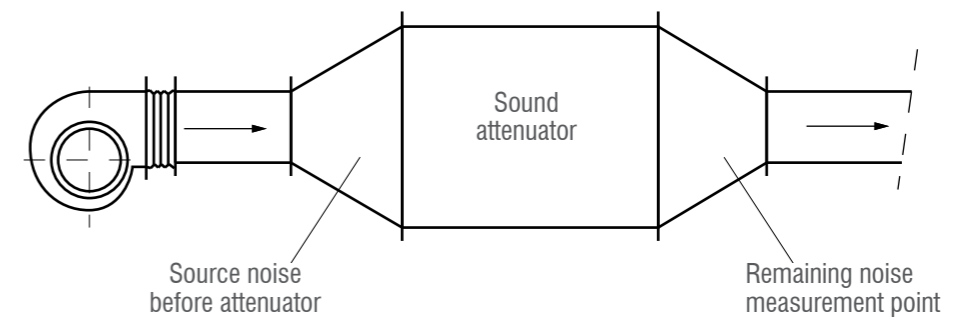

Attenuation diagram, type PZ-R 100/100

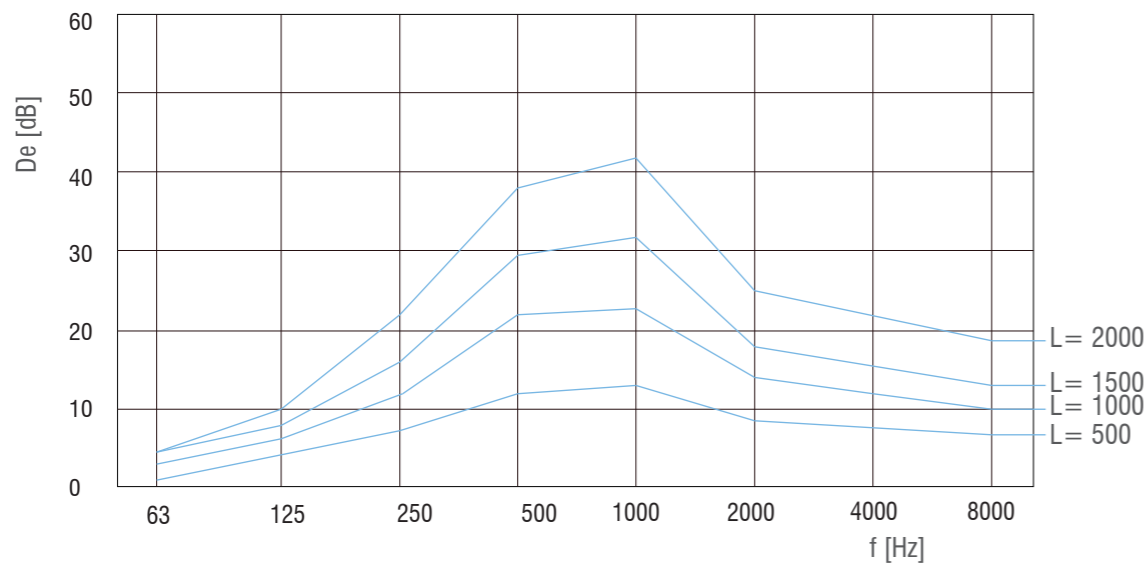

Attenuation diagram, type PZ 200/100

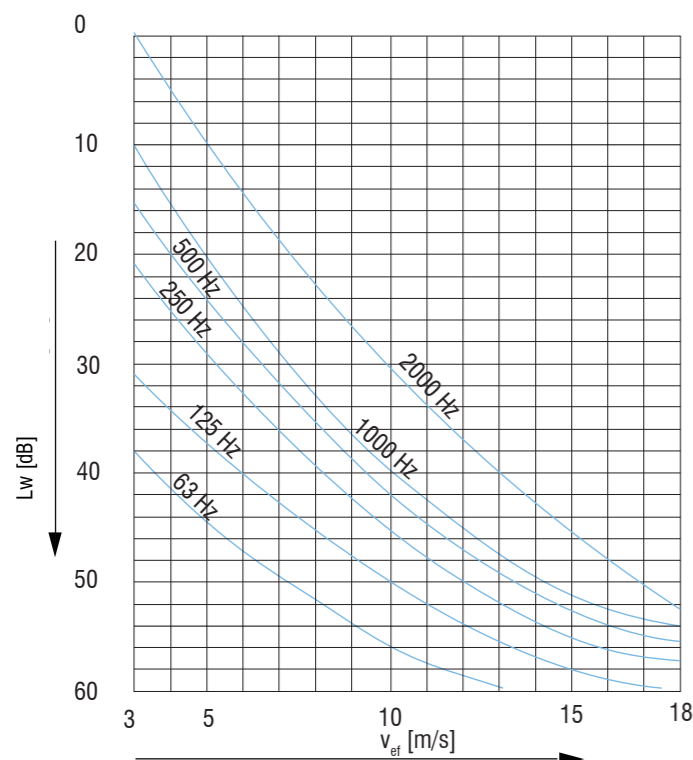
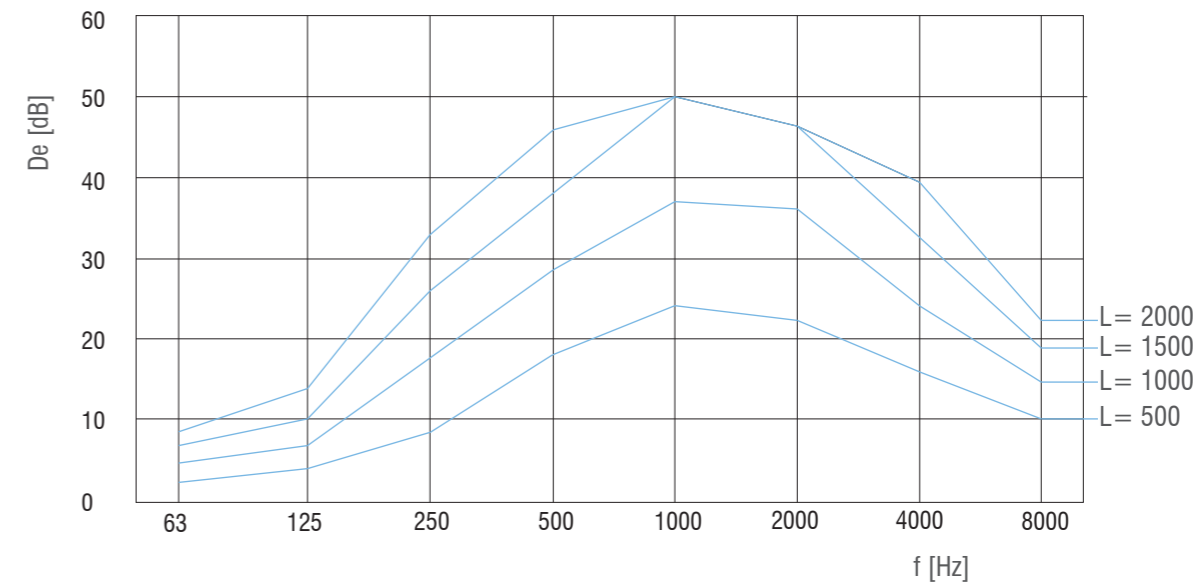

Airflow regenerated noise diagram for d/s = 100/50 (based on outlet size B x H = A<sub>tot</sub> = 1m<sup>2</sup>)

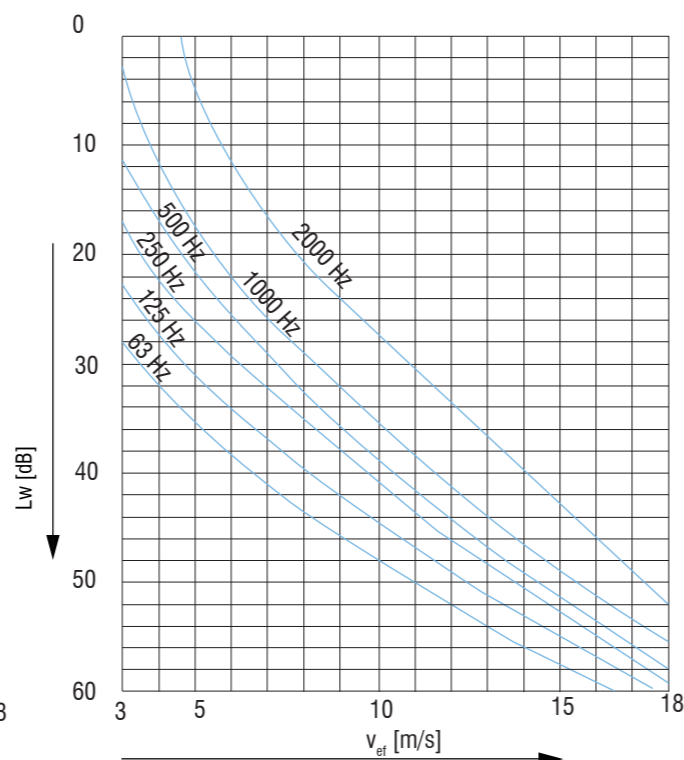

Airflow regenerated noise diagram for d/s = 100/100 (based on outlet size B x H = A<sub>tot</sub> = 1m<sup>2</sup>)

Correction table

A <sub>tot</sub> [m <sup>2</sup> ]	0,25	0,5	0,75	1	1,25	1,5	2
Correction dB (A)	-6	-3	-2	0	1	2	3

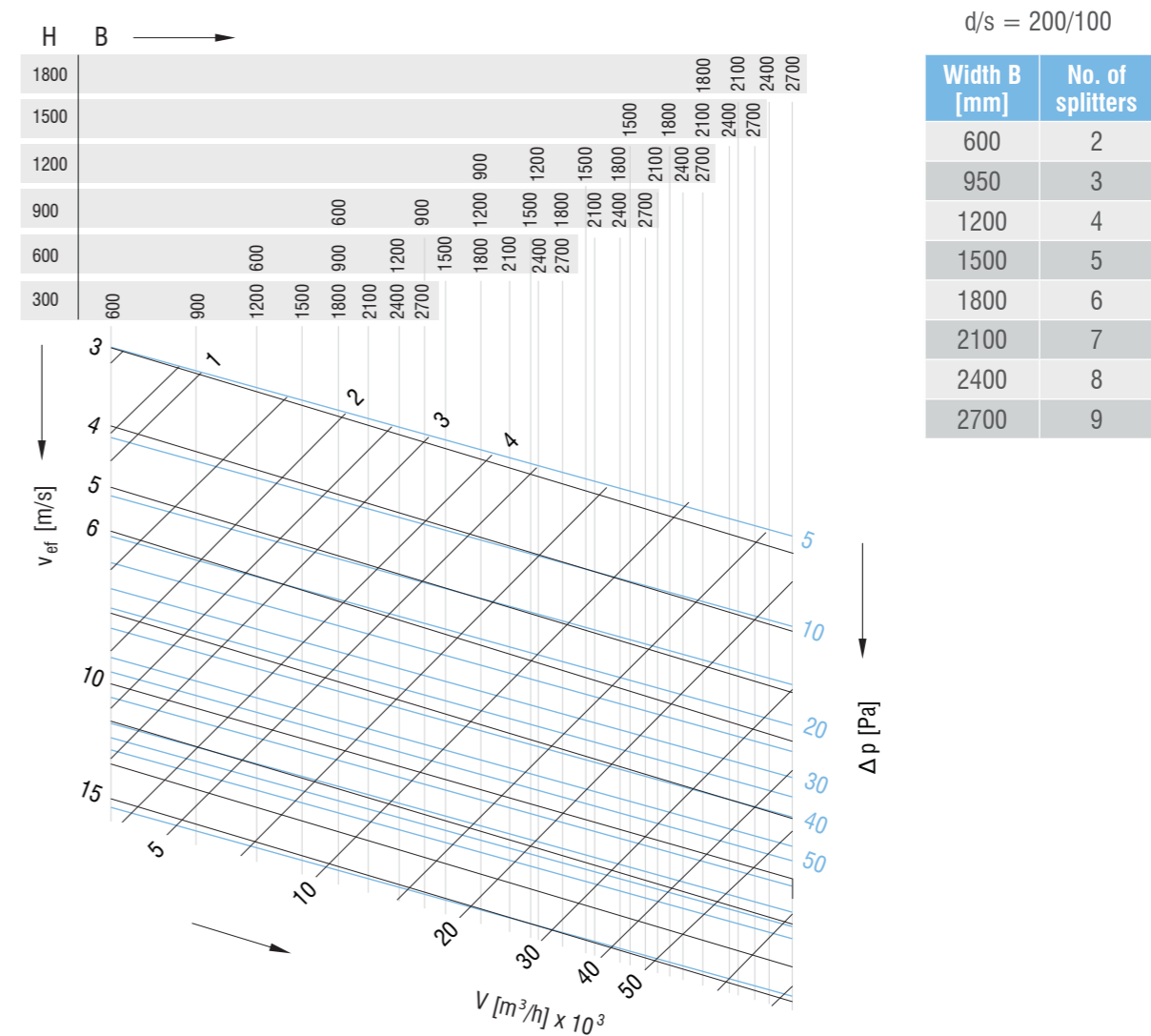

Attenuation diagram, type PZ 200/200

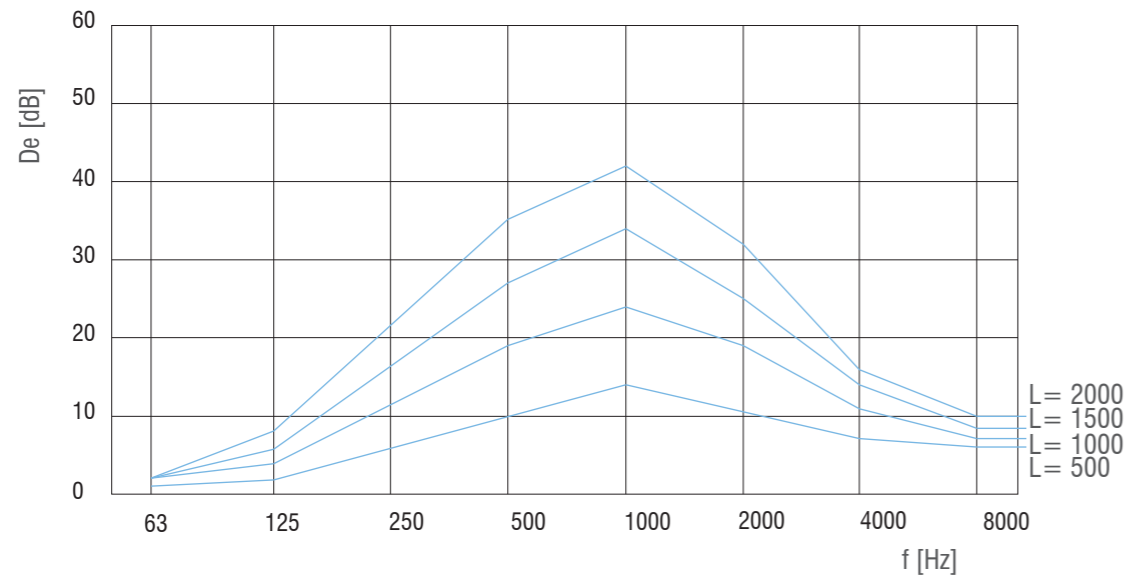

Attenuation diagram, type PZ-R 200/100

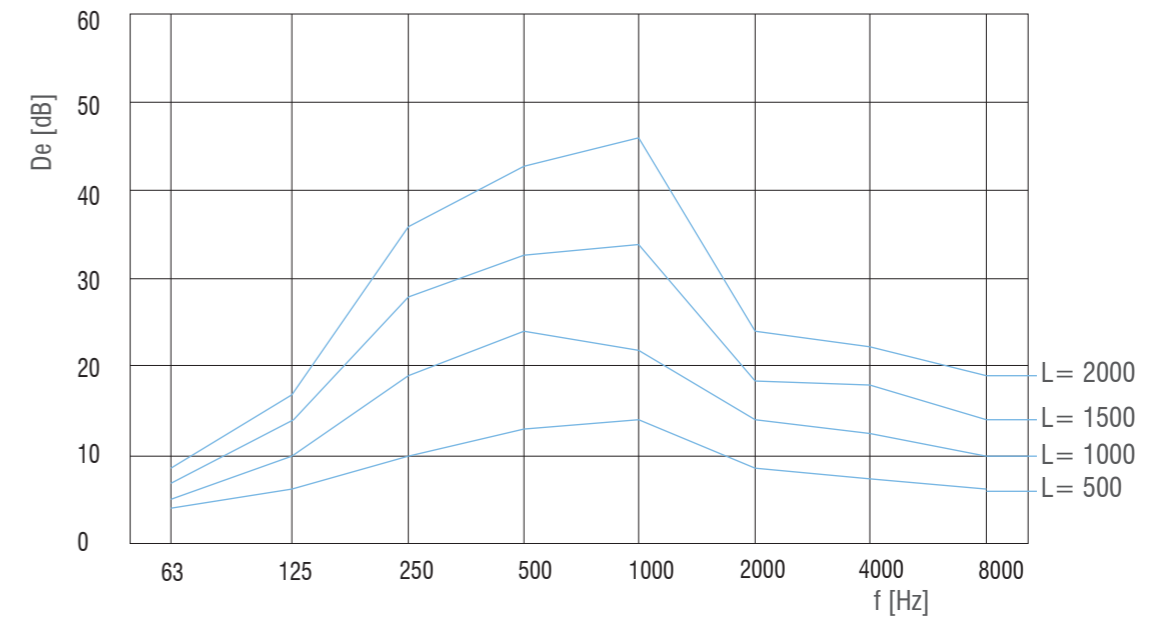

Selection diagram

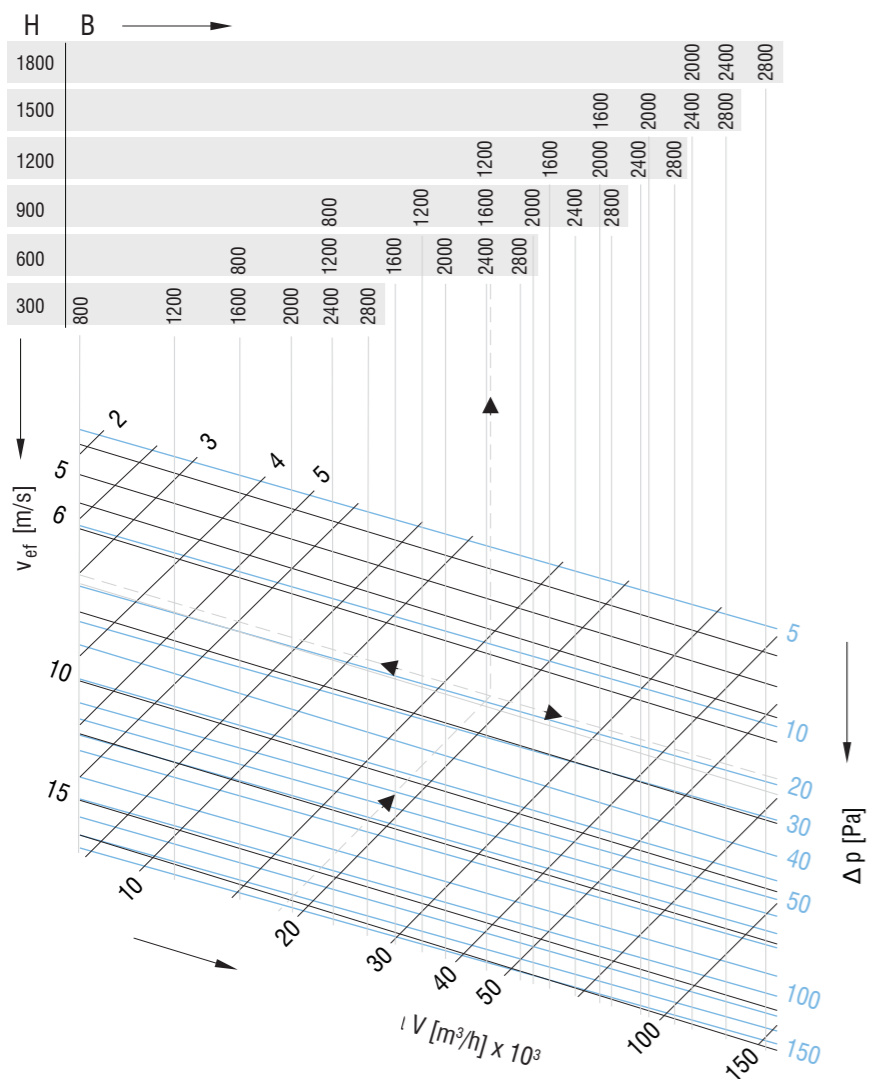

$d/s = 200/200$

Width B [mm]	No. of splitters
800	2
1300	3
1600	4
2000	5
2400	6
2800	7

Example:

Given:  
Airflow rate:  $V = 1800 \text{ m}^3/\text{h}$   
Required attenuation: 18 dB (A) at 250 Hz

Solution:

Dg 1: PZ-R 200/100  
Attenuator length:  $L = 1500 \text{ mm}$

Dg 2: Effective air velocity  $v_{ef} = 7 \text{ m/s}$   
Pressure drop  $\Delta p_{tot} = 17 \text{ Pa}$   
Attenuator cross-section  $B \times H = 2400 \times 600$  or  $1600 \times 900$

Dg. 7: Frequency Hz                      125    250    500

Flow regenerated noise dB (A)        37     32     29

$A_{tot} = B \times H = 0,81 \text{ m}^2$

Tab. 9: correction dB (A)                2      2      2

Total air flow regenerated noise dB(A) 39    34    31

In each octave band noise values determined above have to be by 9 dB(A) lower than the attenuated source noise measured after the attenuator (see Figure).

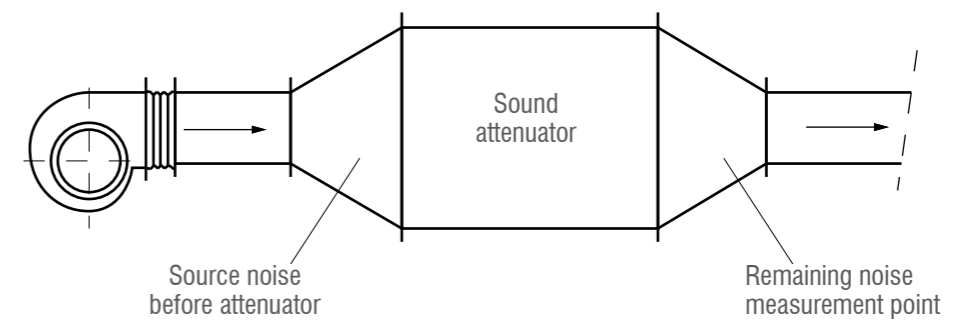

Attenuation diagram, type PZ 300/100

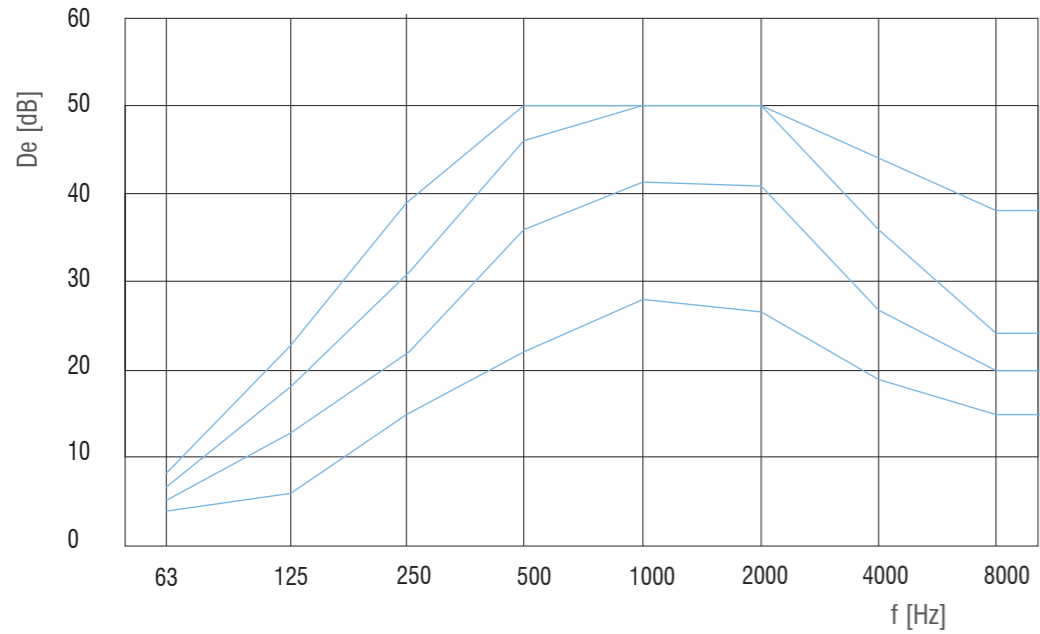

d/s = 300/100

Width B [mm]	No. of splitters
800	2
1300	3
1600	4
2000	5
2400	6
2800	7

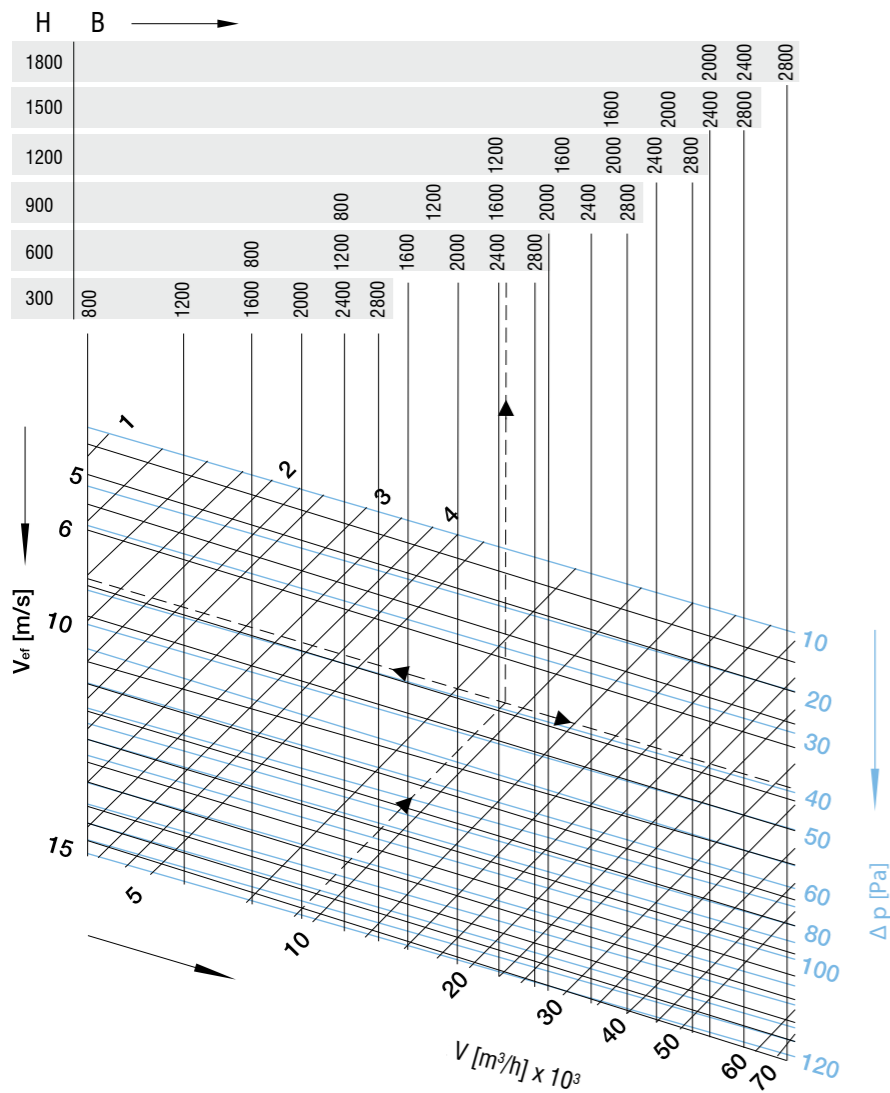

Airflow regenerated noise diagram for d/s = 200/100; (based on outlet size B x H = A<sub>tot</sub> = 1m<sup>2</sup>)

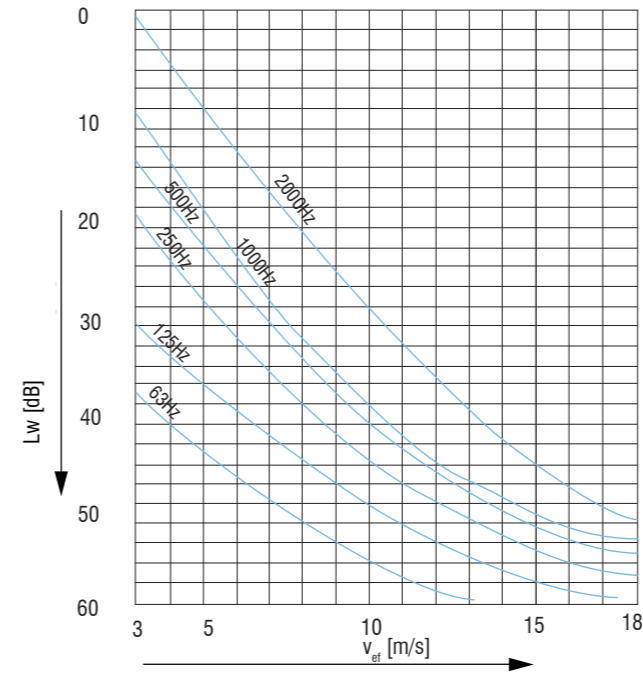

Airflow regenerated noise diagram for d/s = 300/100 (based on outlet size B x H = A<sub>tot</sub> = 1m<sup>2</sup>)

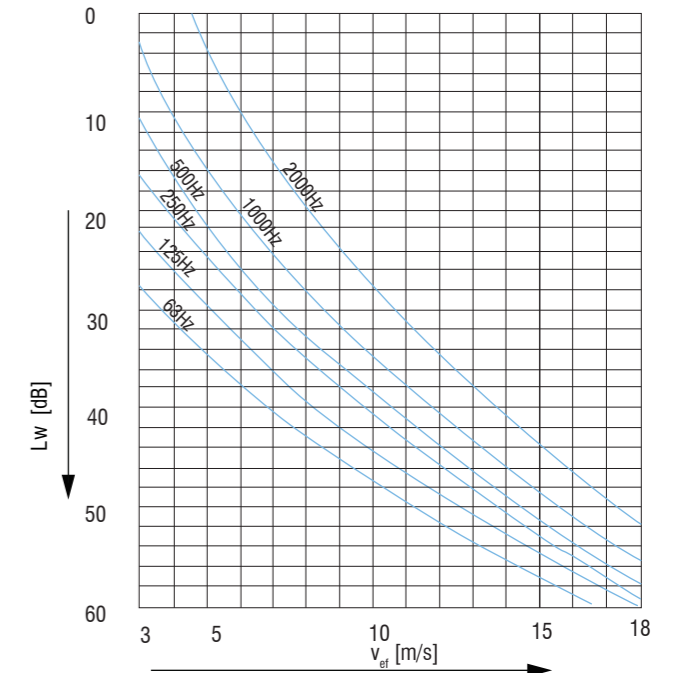

A <sub>tot</sub> [m <sup>2</sup> ]	0,25	0,5	0,75	1	1,25	1,5	2
Correction dB (A)	-6	-3	-2	0	1	2	3

Ordering key:

Sound attenuator **PZ - d / s - B x H x L - S**  
 Splitter width / gap  
 Dimensions  
 Splitter coverings:  
**S** - Glass silk  
**RS** - Reflective plate and glass silk  
**PS** - Perforated plate and glass silk

Splitter **PK - d x H x L - S**  
 Dimensions  
 Designations as for attenuator



**ROUND ATTENUATOR - PZC**

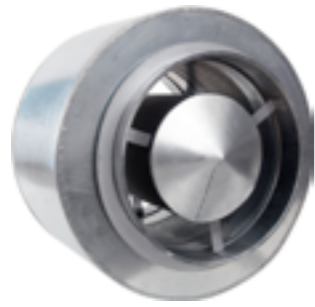

- Outer casing is made of galvanised sheet steel, filled with sound absorbing material. Inner duct of the attenuator is made of perforated galvanised sheet steel

Options

Version with pod

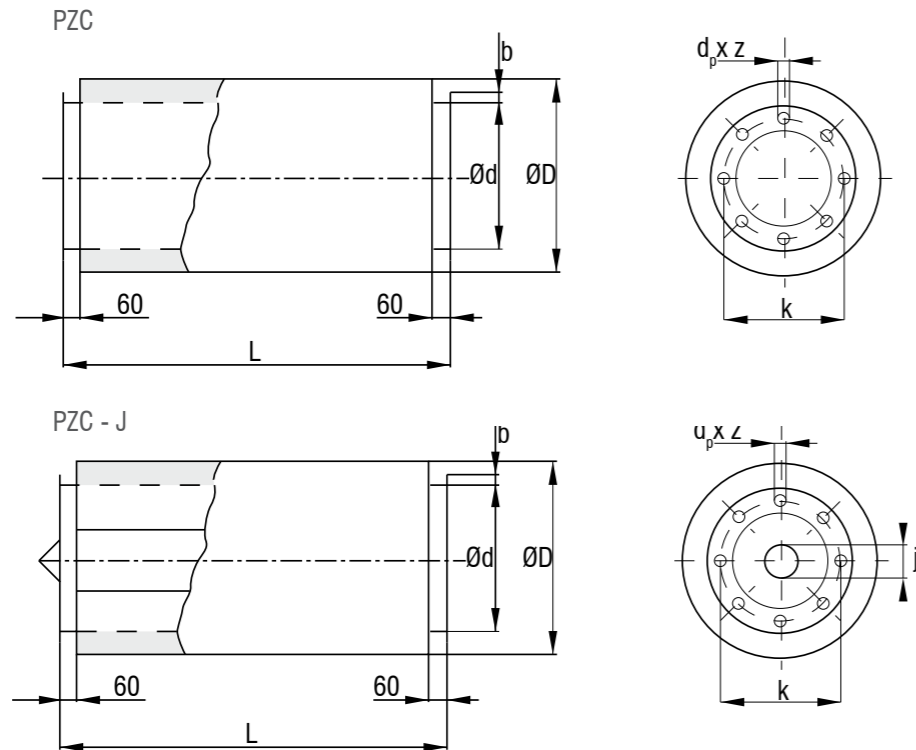

Standard diameter	Flow area [m <sup>2</sup> ]	$\varnothing D$ [mm]	$\varnothing j$ [mm]	Attenuator weight						$\varnothing k$ [mm]	b [mm]	s [mm]	$\varnothing d \times z$
				L=500		L=1000		L=1500					
				PZC	PZC-J	PZC	PZC-J	PZC	PZC-J				
355	0,100	555	224	23	28	40	48	57	68	392	30	4	9,5x8
400	0,126	600	250	25	31	44	53	62	76	438	30	4	9,5x8
450	0,158	650	280	28	35	48	59	68	84	488	30	4	9,5x8
500	0,198	700	315	30	39	52	66	74	93	538	30	4	9,5x8
560	0,251	760	355	33	43	57	73	81	104	600	35	4	9,5x12
630	0,316	830	399	37	49	63	83	89	117	670	35	4	9,5x12
710	0,397	910	450	41	55	70	94	98	132	750	35	4	9,5x12
800	0,499	1000	500	46	62	77	106	109	149	840	35	4	9,5x16
900	0,628	1100	560	51	71	86	120	120	169	940	35	4	9,5x16
1000	0,785	1200	630	56	80	94	136	132	191	1041	35	4	9,5x16

Ordering key

Round attenuator **PZC - J - 560 - L**  
**J** - attenuator with pod  
 Standard size  $\varnothing d$   
 Attenuator length

Attenuation  $D_e$  [dB]

Frequency [Hz]	63		125		250		500		1000		2000		4000		8000	
	PZC	PZC-J	PZC	PZC-J	PZC	PZC-J	PZC	PZC-J	PZC	PZC-J	PZC	PZC-J	PZC	PZC-J	PZC	PZC-J
Attenuator length: L=500																
355	2	2	3	4	6	7	11	12	10	20	6	23	3	20	3	15
400	2	2	3	3	5	6	10	12	8	19	5	21	3	17	2	13
Attenuator length: L=1000																
355	2	3	7	9	11	14	21	24	23	42	12	43	7	39	4	27
400	2	3	6	8	10	13	20	24	19	42	9	41	6	34	4	23
450	2	3	5	7	9	12	19	23	14	42	7	37	4	28	3	19
500	2	3	4	6	8	11	18	22	10	43	4	34	3	23	3	15
560		3		6		11		21		40		31		21		14
630		3		6		11		21		36		28		18		13
710		3		5		10		20		32		24		15		11
800		3		5		10		19		28		20		12		10
900		2		5		10		18		23		15		8		8
1000		2		4		9		17		18		10		5		7
Attenuator length: L=1500																
355	3	3	9	11	14	17	27	31	35	48	19	50	8	43	6	37
400	3	4	8	10	14	16	26	30	29	50	15	50	7	40	5	31
450	3	4	7	9	13	15	25	29	22	50	11	50	6	36	5	25
500	3	4	6	8	12	14	24	28	16	50	6	50	4	33	4	19
560	3	4	5	8	11	14	23	27	14	49	6	46	4	30	4	18
630	2	4	4	7	10	13	21	27	12	48	5	42	4	26	3	16
710	2	3	4	7	9	13	19	26	10	47	4	37	3	22	3	15
800	1	3	3	6	8	12	17	25	7	46	3	32	3	17	2	13
900		3		5		11		24		45		26		12		11
1000		2		5		11		23		43		20		6		9

